













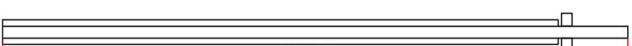

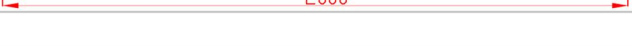



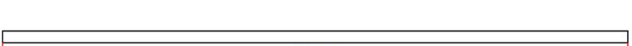



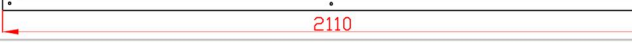

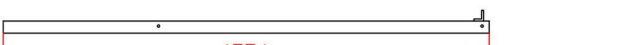
Assembly Instructions For Premier Open Fronted Smoking Shelter





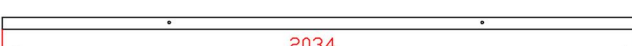

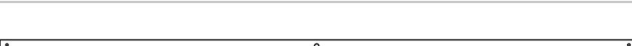
Shelter type: Smoking Shelter

SR0050-01-290617-UK

Parts List 1

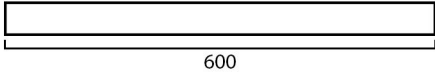
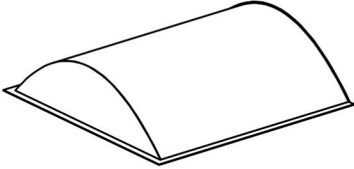
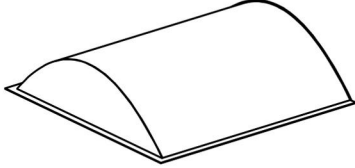
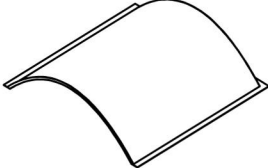
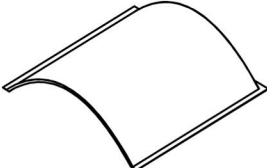
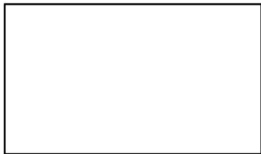
Part Diagram	Part Number	Part Description	48BW
	A48FS-3aC	Upright Single RH	2
	A48FS-3C	Upright Single LH	2
	A48FS-1C	Upright Double	0
	A48FS-2C	Upright Corner	0
	A48FS-3aD	Upright Single RH	0
	A48FS-3D	Upright Single LH	0
	A48FS-1D	Upright Double	0
	A48FS-2D	Upright Corner	0
	A48FS-7	Upright Plain	1
	A48FS-8	Horizontal Full Bay	2
	A48FS-9	Horizontal Half Bay	0
	A48FS-4	Roof Side 2 Bay Box	0
	A412FS-2LH	Roof Side LH 3 Bay Box	2
	A412FS-2RH	Roof Side RH 3 Bay Box	2
	A416FS-4LH	Roof Side LH 4 Bay Box	0
	A416FS-4RH	Roof Side RH 4 Bay Box	0
	A820FS-1LH	Roof Side LH 5 Bay Box	0
	A820FS-1RH	Roof Side RH 5 Bay Box	0
	A820FS-2	Roof Side Ctr 5 Bay Box	0
	A48FS-5	Roof End x1 Box	0
	A88FS-2	Roof End x2 Box	2
	A811FS-2	Centre Tie Bar x2	0
	A416FS-5	Centre Tie Bar x1	0
	A48FS-14	C type Glazing Bead	4
	A48FS-13	D type Glazing Bead	0

PARTS LIST & FITTINGS

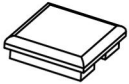
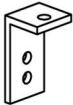
Part Diagram	Part Number	Part Description	48FS
	A412FS-12	Roof Support Bar	1
	A48FS-6	Roof Ends x1	0
	A88FS-1	Roof Ends x2	2
	A412FS-1	Roof Middle x1	0
	A811FS-1	Roof Middle Double	1
	NBB910	Plastic Glazing Panels	2
	NBB911	Plastic Glazing 1/2 Panels	0
	A48FS-12	Roof Trim	0
	A88FS-3	Roof Trim	2
	A48FS-T	Std Foot (L) Assembly, with screw	5
	NBB903 4	End Caps Square	6
	A48FS-16	Top Bracket (Thread with allen bolt)	5
Fixing Images Not Shown	NBB915	Anchor Bolt	5
	NBB901	Wafer Head Screw	8
	NBB907	Hex Head Screw	40
	NBB902	M6x12 Poz Screw	10
	NBB906	M8x40 allen bolt	0

Step 1

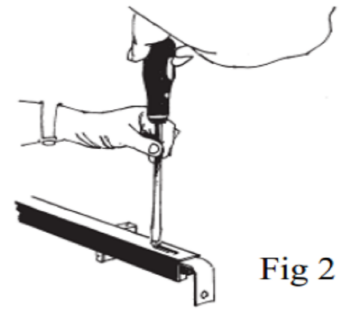
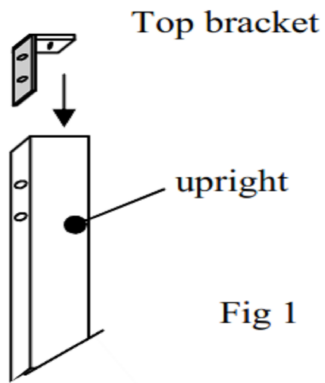

Attach all five "Top Brackets" (**A48FS-16**) to the top of the five upright posts as shown in (Fig 1) The Bracket sits inside the post.

Next locate the "Std Foot" (**A48FS-T**) and attach it to the opposite end of the upright posts as shown in (Fig 2) The groove allows for slight height adjustment for uneven ground.

Step 2

with one person holding the "Uprights Corner" (**A48FS-2C**) upright.

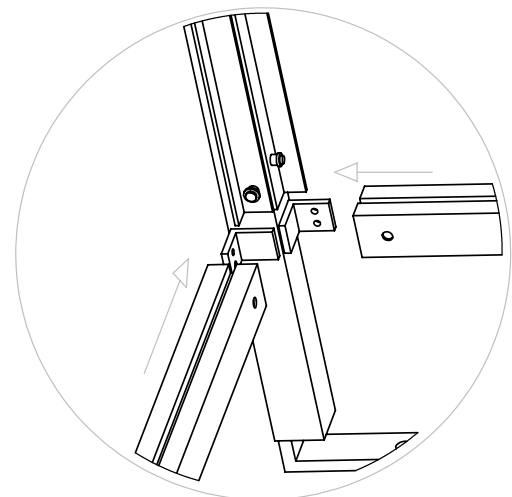
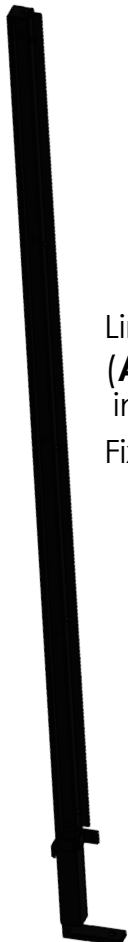

Line up two of the "Horizontals Full Bay" (**A48FS-8**) so that the (L) shaped bracket fits inside the end as shown in (Fig 3 and 4).

Fix in place with a Hex Head Screw

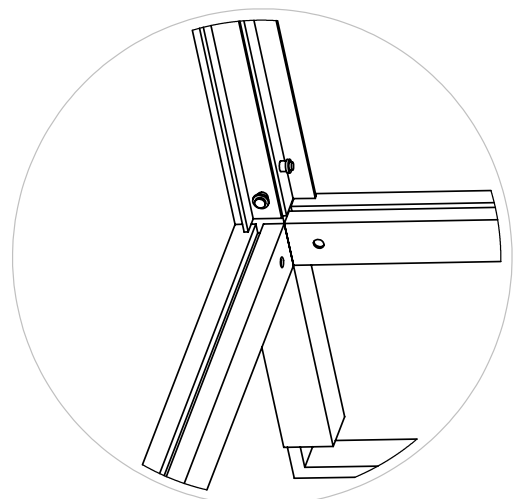

Step 3

2 half's of the shelter

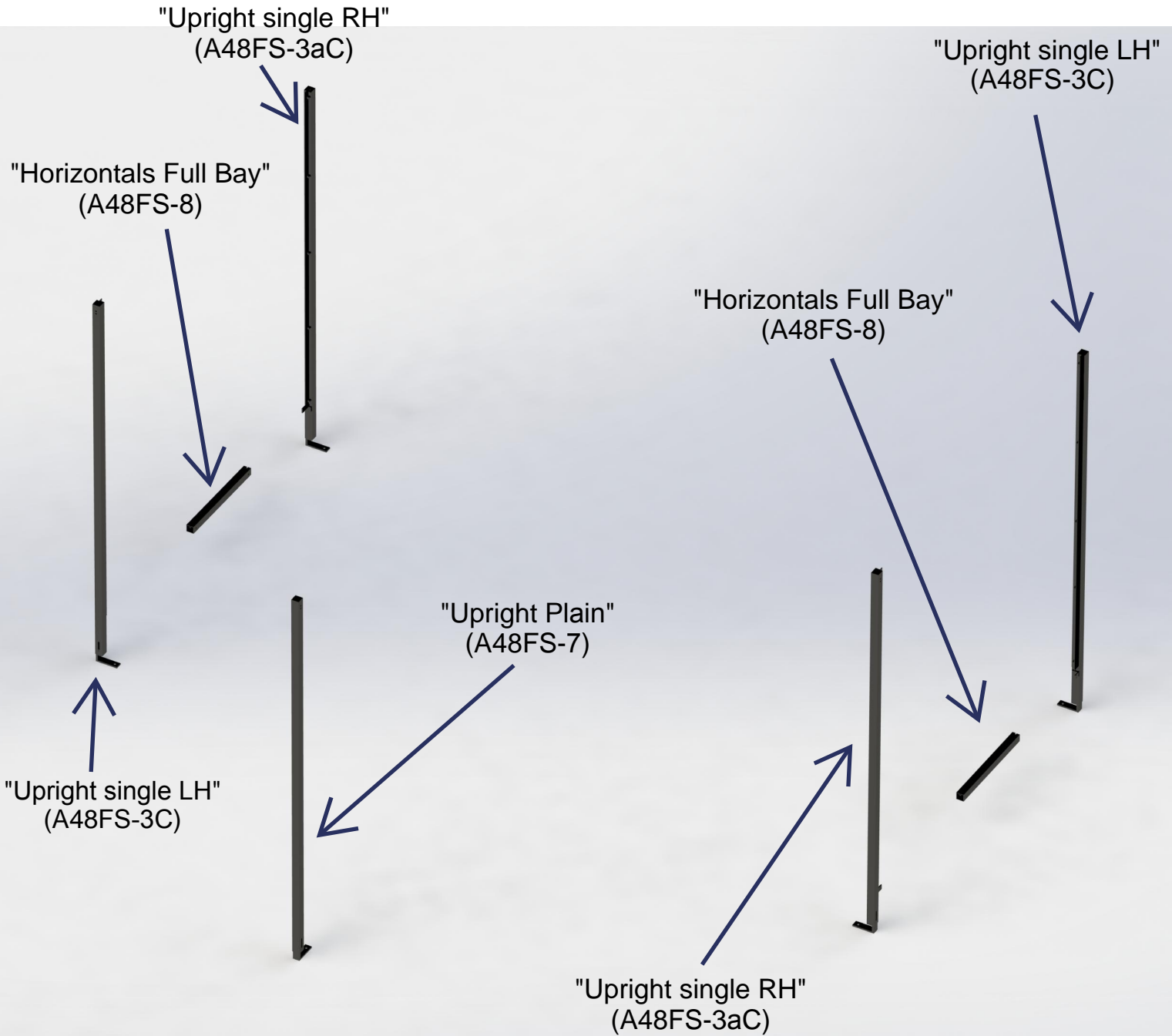

The method of construction is to assemble the frame and roof then when complete move the shelter into position and secure to the wall.

Select the back single upright, one horizontal bar, the side bar and the next upright in the sequence. Firstly, slide a horizontal bar (groove up) onto the upright brackets and loosely secure using M6x12 screws. Then, attach the next upright in a similar manner. Slide a plastic panel into place between the glazing angle and glazing bead studs, ensuring that it is correctly located in the horizontal groove. Then place the roof bar over the upright studs (or insert a M8 allen bolt) again ensuring that the plastic is correctly located in the upper groove, Once attached tighten the bolts loosely in place. If appropriate fix the Tie Bar as the construction of the shelter continues. See Fig 4

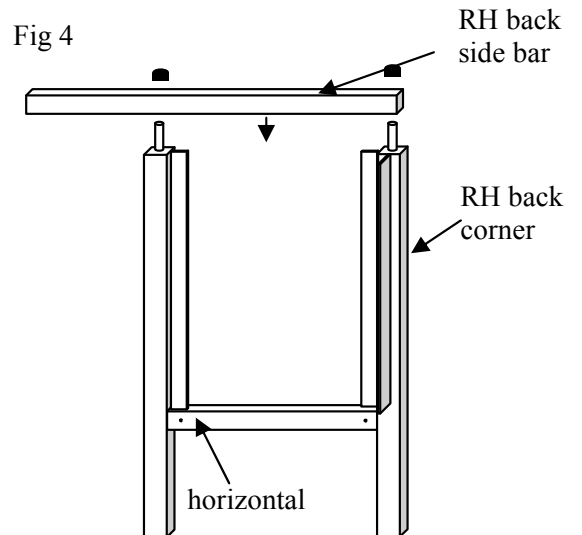

Step 4

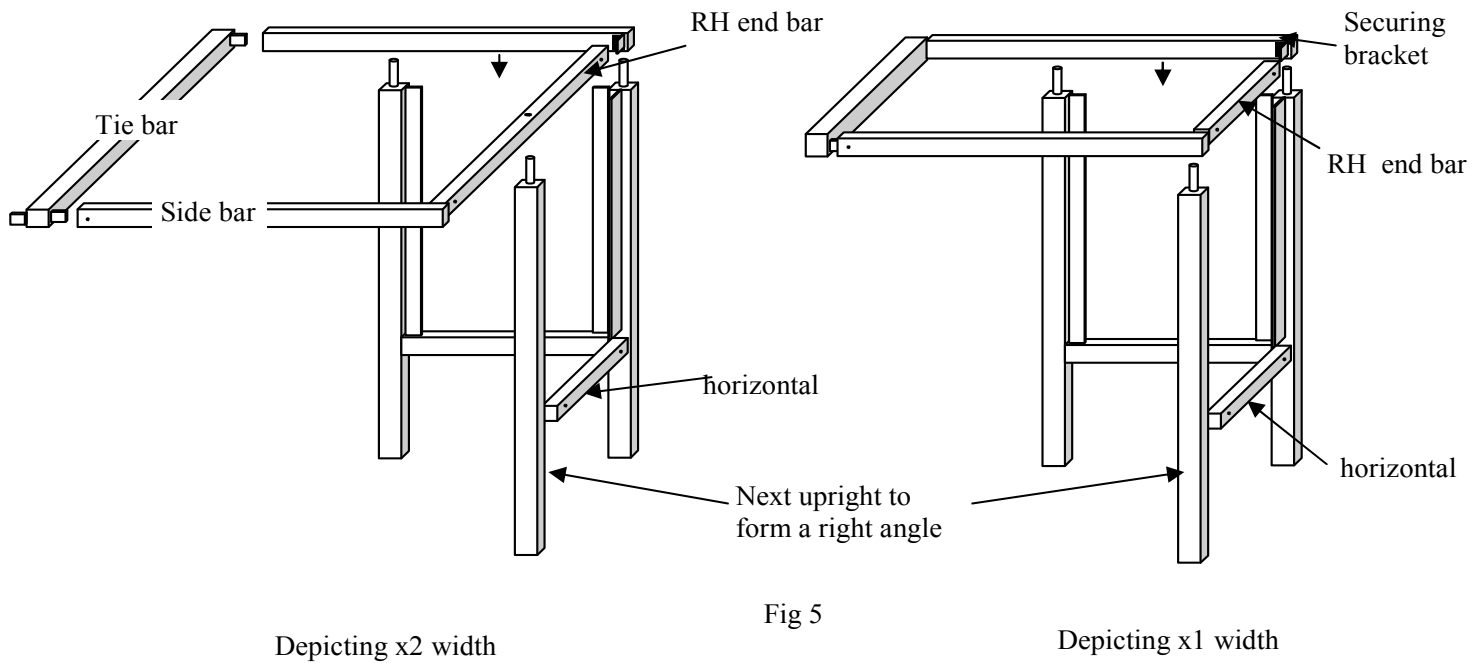

Examine the layout drawing for your shelter and continue the construction until the frame is complete. Note when fitting the end bars they are easier to fit if the corner is lifted slightly.

If the shelter is over 2 metres long it is advisable that the tie and both sides are fitted as the assembly progresses i.e. to form rectangular roof structures. See Fig 5. This is particularly important in the building of "CC" type and Back Wall shelters as the frame is unstable until the assembly is complete. For this reason it is also not advisable to attempt construction on windy days.

Once all of the panels have been assembled, you should ensure that the shelter is level. If necessary the foot brackets can be adjusted. This is also an opportune time to ensure that all of the panels are square. This can be achieved by measuring the diagonals, that should be equal. Figs 6 & 7

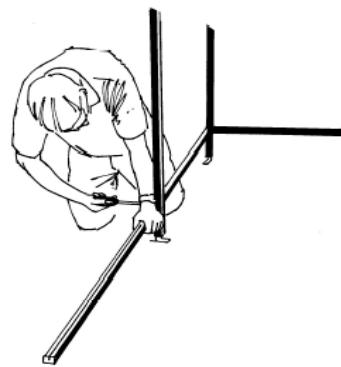

Fig 6

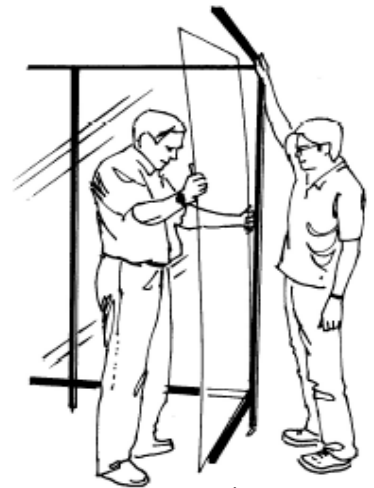
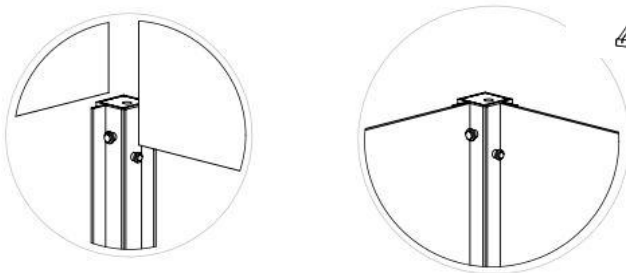

Fig 7



The glazing beads can now be positioned and snapped into place over the pre-positioned glazing studs. Fig 8. To snap the glazing bead into position take a small block of wood and a mallet. By starting at the bottom tap the glazing bead over the studs.

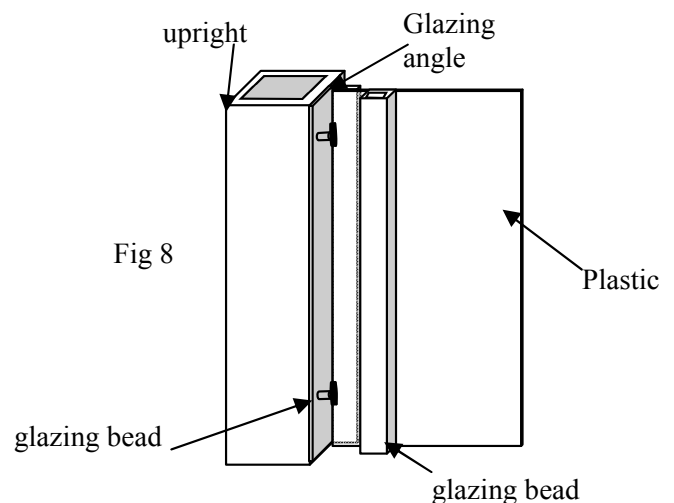
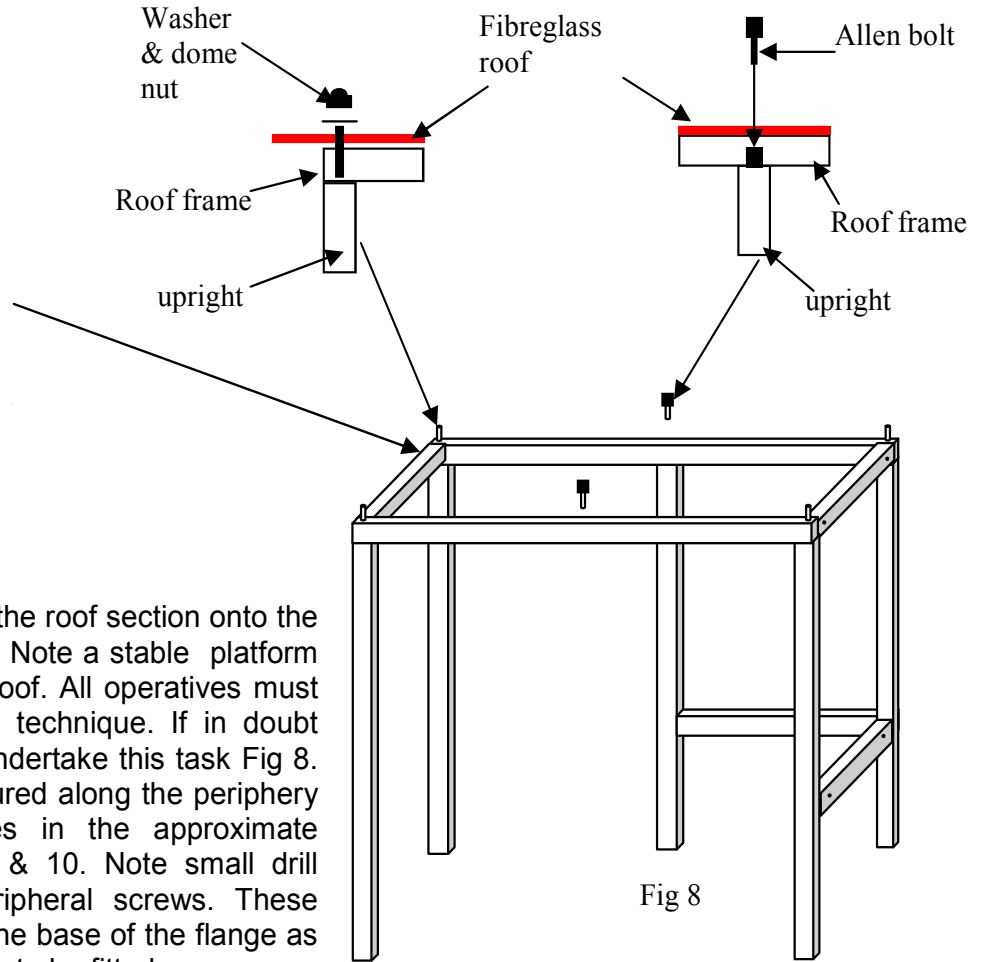

Fig 8

Step 5



Once the frame is assembled lift the roof section onto the frame and secure with dome nut. Note a stable platform must be used when raising the roof. All operatives must be advised of the correct lifting technique. If in doubt recruit additional personnel to undertake this task Fig 8. The roof sections should be secured along the periphery and around the joining flanges in the approximate positions as indicated in Fig 9 & 10. Note small drill screws are provided for the peripheral screws. These should be positioned as near to the base of the flange as possible to allow for the Roof Trim to be fitted.

Fig 8

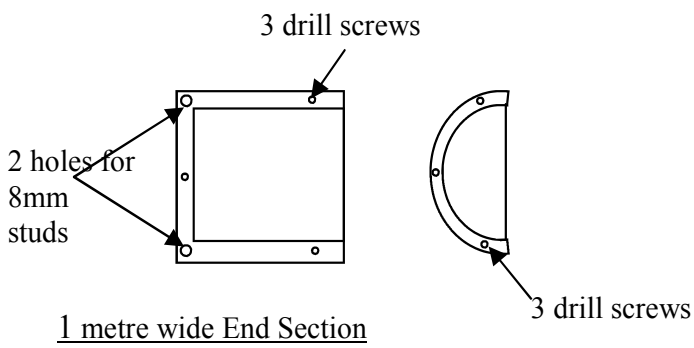

1 metre wide End Section

Fig 9

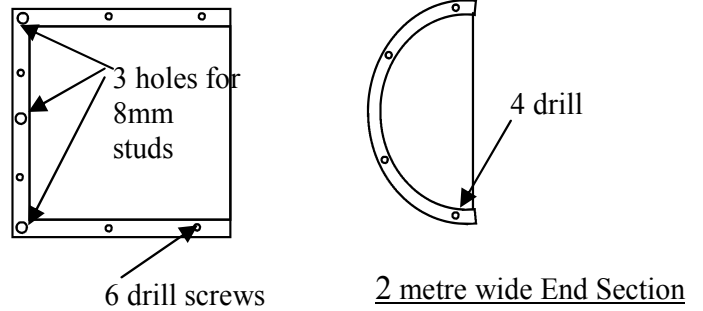

2 metre wide End Section

Fig 10

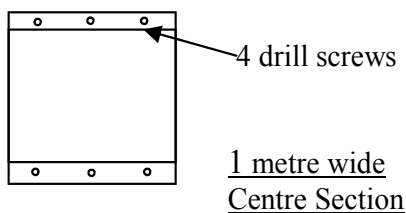

1 metre wide Centre Section

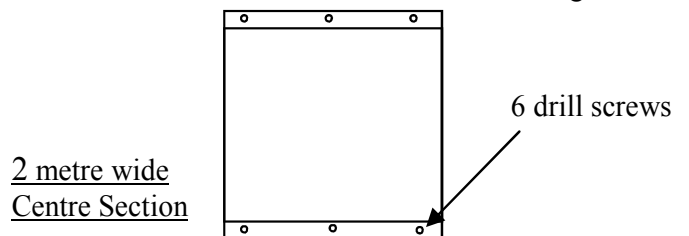

2 metre wide Centre Section

Step 6

Once the roof has been secured to the roof frame the Roof Trim can be tapped into place over the roof flange. Fig 11

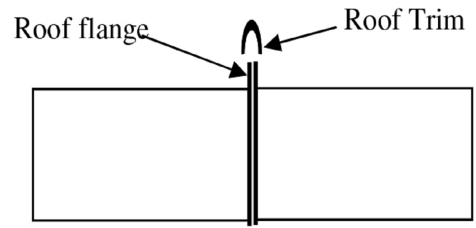

Fig 11

Step 7 (Final Assembly and fixing)

On completion the shelter must be secured with 8 mm bolts. Usually these are 100 mm long however the length and type of fixing will depend on the ground surface or substrate, but they must be suitable for retaining the shelter in high winds. Fig 12

Choice of type and length of fixings employed will depend on the following:

1. **Substrate/surface:** A concrete base will require different fixings to tarmac for instance. Also the age and density of tarmac will effect the choice of fixing.
2. If the shelter is in an exposed position, it can be orientated so the back faces the usual wind direction. But the force of the wind or the shelter of a building will affect the choice of fixings.
3. There may be other considerations which might affect the choice of position, substrate and choice of fixings.

A thorough inspection of the proposed site should be undertaken prior to assembly

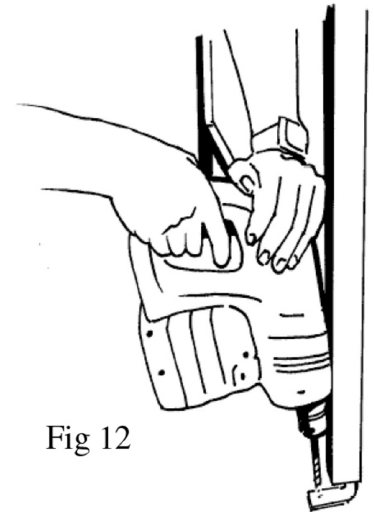

Fig 12

Final Inspection and Maintenance.

Once the shelter has been successfully erected, check once more that all the bolts and screws are fully secured. Clean down sheeting if necessary and it is recommended that a soapy non-abrasive solution is used periodically to maintain the cleanliness of the shelter. If the shelter has been scratched during assembly, free black touch-up paint is available

NOTES:

NOTES:

NOTES:

THANK YOU FOR PURCHASING THIS PRODUCT

MAINTENANCE:

To ensure your products give you many years of use we recommend that you:

- Clean panels regularly with soapy water
- Ensure all fittings are tight (for example after a big storm)
- Touch up any exposed metal should it get scratched

CONTACT DETAILS:

Email : sales@shelters4less.co.uk

Web : www.shelters4less.co.uk

Tel : 0800 160 1002

**Shelters4Less, Unit 3, 2 Lansdowne Crescent,
Bournemouth, BH1 1SA**

All Parts and Fixings checked by:	
Print Name:	Signature: